

Landy

# Pump Solutions

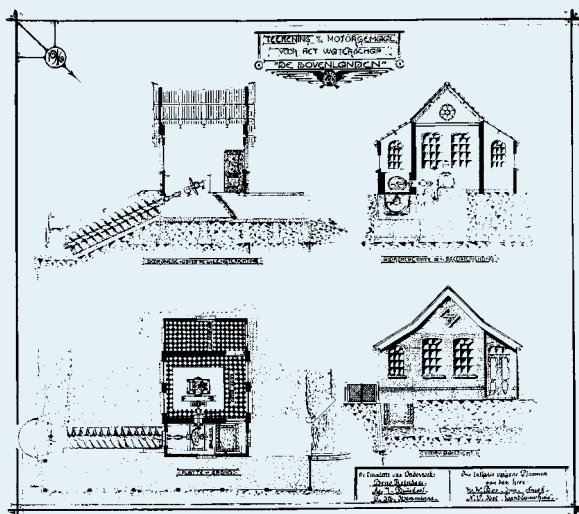

## Wastewater

The experience we have gained over 100 years shows that wastewater is never the same. Some is relatively clean, elsewhere the water is contaminated with large solids, long fibres, chemicals or a complicated combination. There is no “one size fits all” solution for the challenges faced by our customers. That is why Landustrie offers such a wide range of products to transport wastewater.

## LANDY PUMPS

The philosophy behind the design of our wastewater pumps, both submersible and dry-installed, is quality, keep it simple, long life and less maintenance, thus reducing lifetime costs and being better for the environment. More robust, stronger, dedicated to the job and tailored to your demands. These basics are what you will find in all products that are built and tested in our workshops in Sneek. Since wastewater can be contaminated with different materials and chemicals, Landustrie can supply the pumps in a wide variety of materials and with the necessary certificates. For you as the customer, Landustrie’s goal is to fulfil your pump challenges in a satisfying way.

## EXPLOSION PROOF

LANDY submersible pumps are available Explosion proof, certified to ATEX II2G Ex bcd IIB T4 Gb. When frequency controlled ATEX II2G Ex bcd IIB T3 Gb. Dry-installed and hydraulically driven pumps are available with various ATEX certifications.



## OVER 100 YEARS OF HISTORY

- In 2013 Landustrie celebrated its 100th anniversary.
- The foundations were laid around 1913, when the company was active in the agricultural sector and the evolving phases of polder drainage. As early as 1916, electrically driven pumping stations were installed with Archimedes screw pumps alongside countless wind driven pumping stations. Production progressed rapidly and in addition to the polder drainage pumps a range was developed to handle sewage. By the 1950s these advances contributed to wastewater purification units being used widely and efficiently.
- From the very beginning Landustrie has played a pivotal role in the development and improvement of pumps with dozens of new types and styles being introduced.
- Landustrie continuously strives to achieve the most efficient pumping solution.



## PUMP SELECTION

Selecting pumps for clean water is quite simple, but, selecting pumps in wastewater is a different story. Landustrie will supply the right pump for your project by taking some basic rules into consideration. The best non-clogging performance is achieved with Vortex impeller pumps, whereas larger volumes are pumped using closed screw impeller pumps. Cutter pumps are employed in specific situations where longer fibres are involved.

In general Cast Iron is suitable for most purposes, Duplex is used for chemical and abrasive contaminated wastewater, and Nihard4 material is used for highly abrasive wastewater. Thanks to the modular construction of LANDY pumps they can be built in various materials and combinations.

Selecting LANDY centrifugal pumps is achieved by adhering to the principles of form and size of solids, chemical contamination and the presence of abrasive materials or long fibres. Also the surrounding environment such as the possibility of explosion which needs to be taken into consideration.

Typically, for water that is highly contaminated with solids and long fibres we will offer the Vortex principle which gives outstanding, non-clogging performance. In situations where power consumption is more important we will offer the closed screw centrifugal impeller. This type of impeller is the new generation single channel impeller performing with high efficiency and good non-clogging performance. For duties with very large capacity and low head we offer Archimedes screw pumps, which are non clogging, highly efficient and reliable. Cutter pumps are used in cases where there are high concentrations of solids and fibres.

## LANDY-SEL PUMP SELECTION PROGRAM

Our philosophy of “keep it simple” is continued in the LANDY-Sel pump selection program. Using a clear interface with basic questions the program guides you to the best selection. Pipework and friction loss calculations are also covered in the program along with the individual data sheets for all pumps.

## TESTING FACILITIES

All LANDY pumps are checked hydraulically in our own test facility prior to shipping. A witnessed test certificate is available. All pumps are supplied with a unique serial number and test curve.



## QUALIFICATION

Landustrie is certified according ISO 9001, EN-ISO 3834-2, ATEX and VCA\*\* (Safety Checklist Contractors). All our products are manufactured according to European guidelines such as the Machinery Directive, Low Voltage Directive and the EMC Directive.

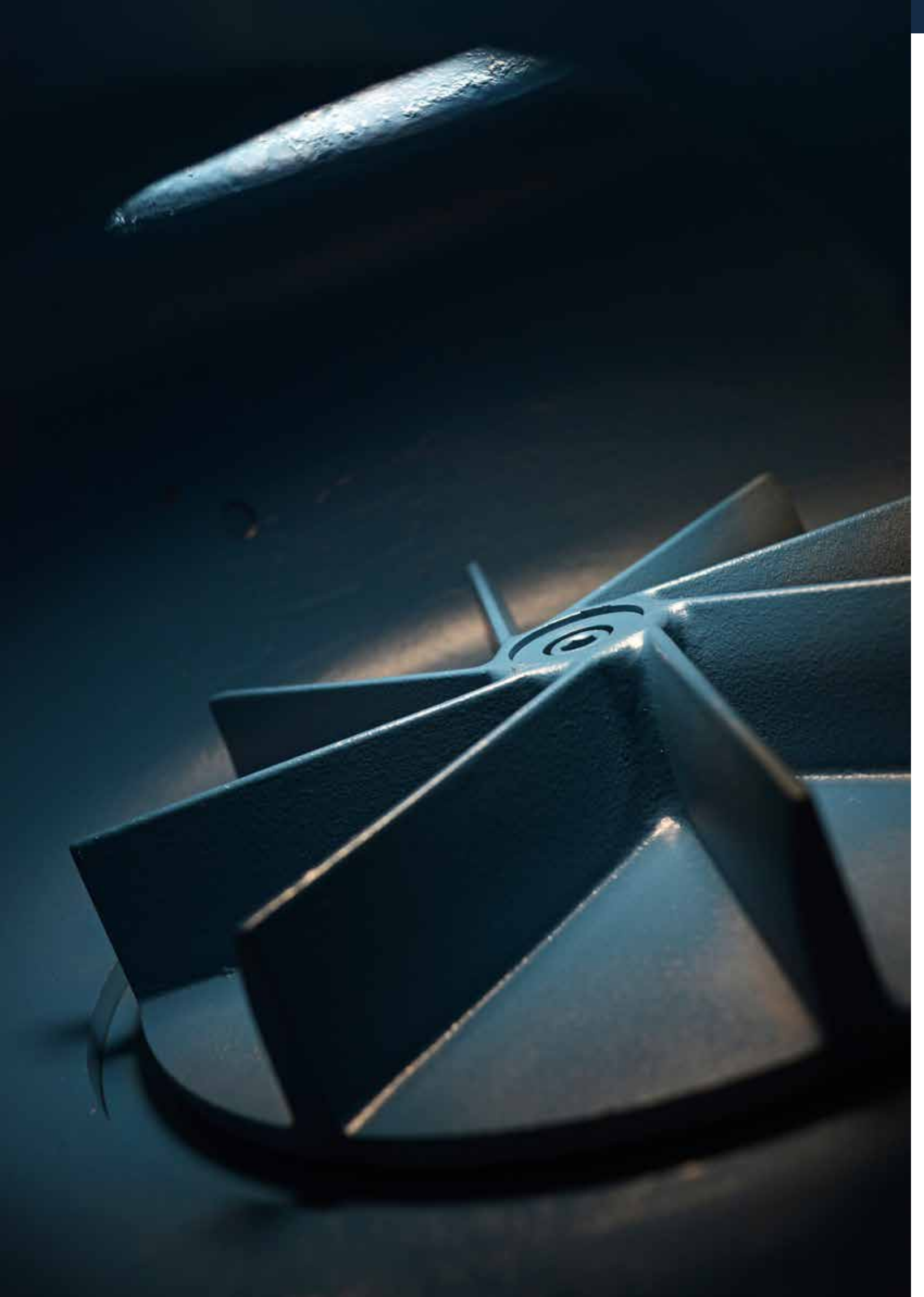

## LANDY VORTEX PUMPS

LANDY Vortex impeller pumps are designed to pump a wide variety of liquids that are contaminated with solids. Their great advantage is the outstanding non-clogging performance.

In standard Cast Iron construction, Vortex pumps are used for sewage and other wastewater applications to pump large solids, highly concentrated solids, large fibres and heavy and gassy sludges. For industrial applications, hydraulic component parts are available in special materials to resist both abrasive and corrosive elements.

The Vortex impeller's non-clogging performance is based upon a simple law of physics, creating a Vortex in a fluid results in a vacuum directly underneath and around the pump. As the impeller does not come into contact with the solids in the pumped medium the pump cannot clog. A simple but very effective principle, resulting in a cleaner sump because the rotating movement of the fluid keeps the solids suspended.

### Low wear – Low vibration

Natural low wear is experienced in Vortex pumps, as most solids pass in front of the impeller without touching it. This also leads to low vibration levels.

### Constant performance – Low maintenance

The absence of narrow clearances eliminates blockage problems. No need for adjustments or replacement of wear rings are necessary to maintain performance. Thus guaranteeing long-term, constant high performance with minimal maintenance, which means the total cost of ownership is therefore extremely low.

## Problem solver

Landustrie will recommend Vortex pumps in situations where other pumps fail and are clogging. Vortex pumps are real problem solvers!

## Advantages

- Best non-clogging performance
- Most reliable principle
- Low impeller wear
- Minimal vibrations
- Constant performance
- Cleaner sumps due to the created Vortex

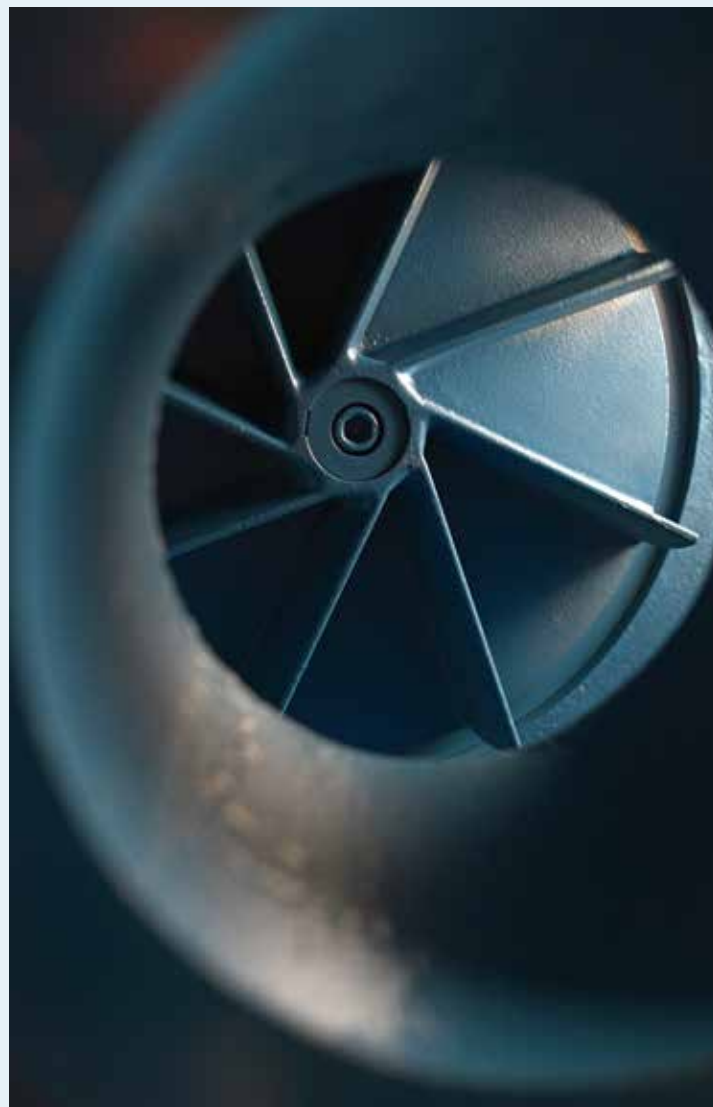

## Cast Iron DWP22/42/62

The unmatched solids handling performance of this range makes these pumps your first choice for most applications. Vortex pumps handle larger and heavier solids, and fibrous materials, heavy and gassy sludges are pumped with ease.

**Options:**

BWK / OWK / VRS / Cooling jacket/ ATEX /

IEC-Ex 

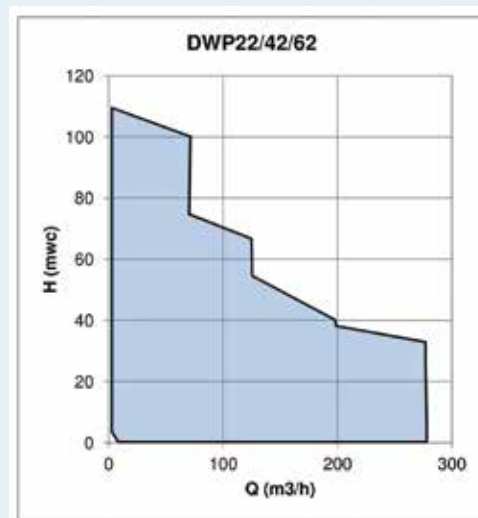

## Nihard-4 DNP22/42/62

Vortex impeller pumps in wear resistant Nihard 4 for reliable transport of highly abrasive solids. For dredging, mining, construction works and other highly demanding applications.

**Options:**

BWK / OWK/ VRS / Cooling jacket/ ATEX /

IEC-Ex 

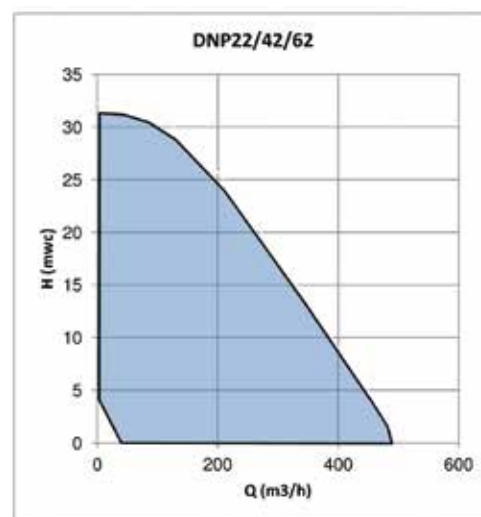

## Duplex DWP22/42 - U

Vortex impeller pumps in Duplex for reliable transport of abrasive and aggressive solids. For wastewater in the food sector, chemical and other very demanding applications with either chemical, abrasive or a combination both.

**Options:**

BWK / OWK/ VRS / Cooling jacket/ ATEX /

IEC-Ex 

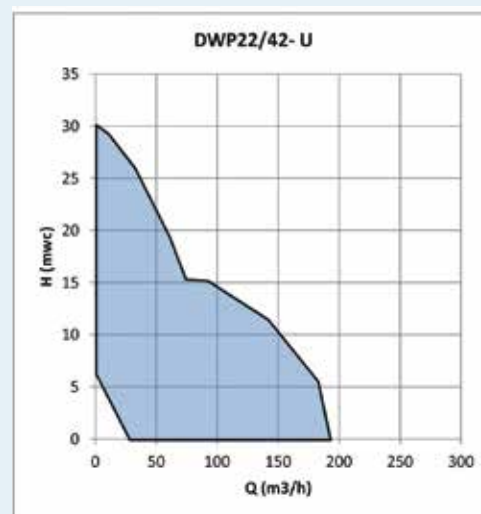

## Cast Iron BWP22/42/62/82

The unmatched solids handling performance of this range makes these pumps your first choice for most applications. Vortex pumps can handle larger and heavier solids, and fibrous materials, heavy and gassy sludges are pumped with ease.

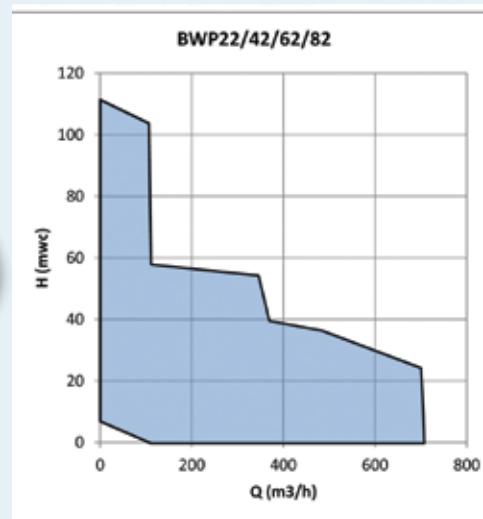

**Options:**

HX / HS / HM / HF / KM / VX / VS / VM / ATEX / IEC-Ex

## Nihard-4 BNP22/42/62

Vortex impeller pumps in wear resistant Nihard 4 for reliable transport of highly abrasive solids. For dredging, mining, construction works and other demanding applications.

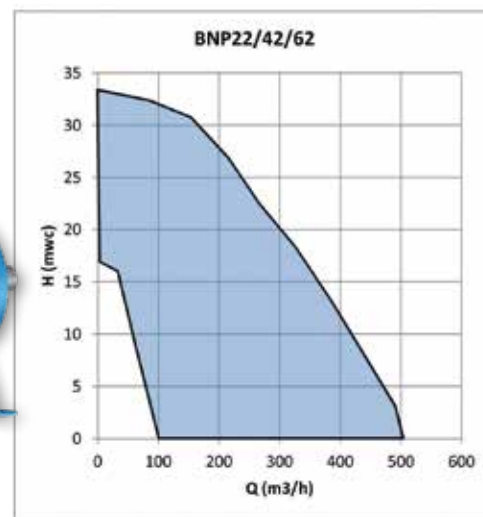
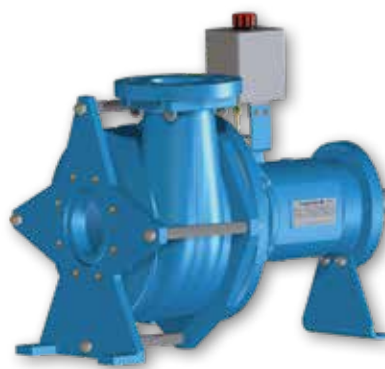

**Options:**

HX / HS / HM / HF / KM / VX / VS / VM / ATEX / IEC-Ex

## Duplex BWP22/42/62 - U

Vortex impeller pumps in Duplex for reliable transport of abrasive and aggressive solids. For wastewater in the food sector, chemical purposes and other demanding applications either chemical, abrasive or a combination of both.

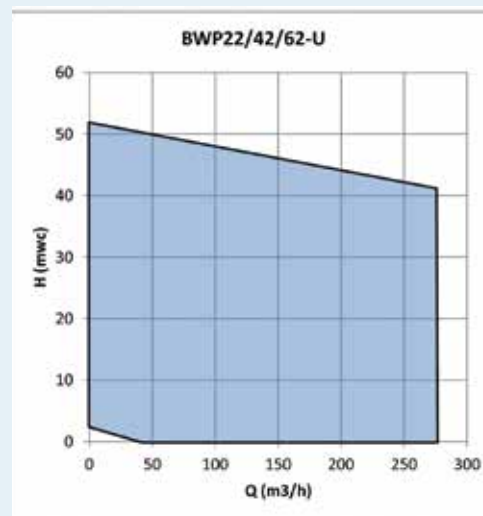
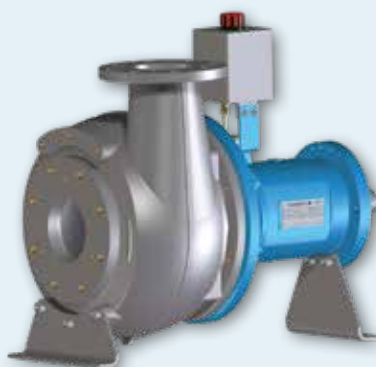

**Options:**

HX / HS / HM / HF / KM / VX / VS / VM / ATEX / IEC-Ex

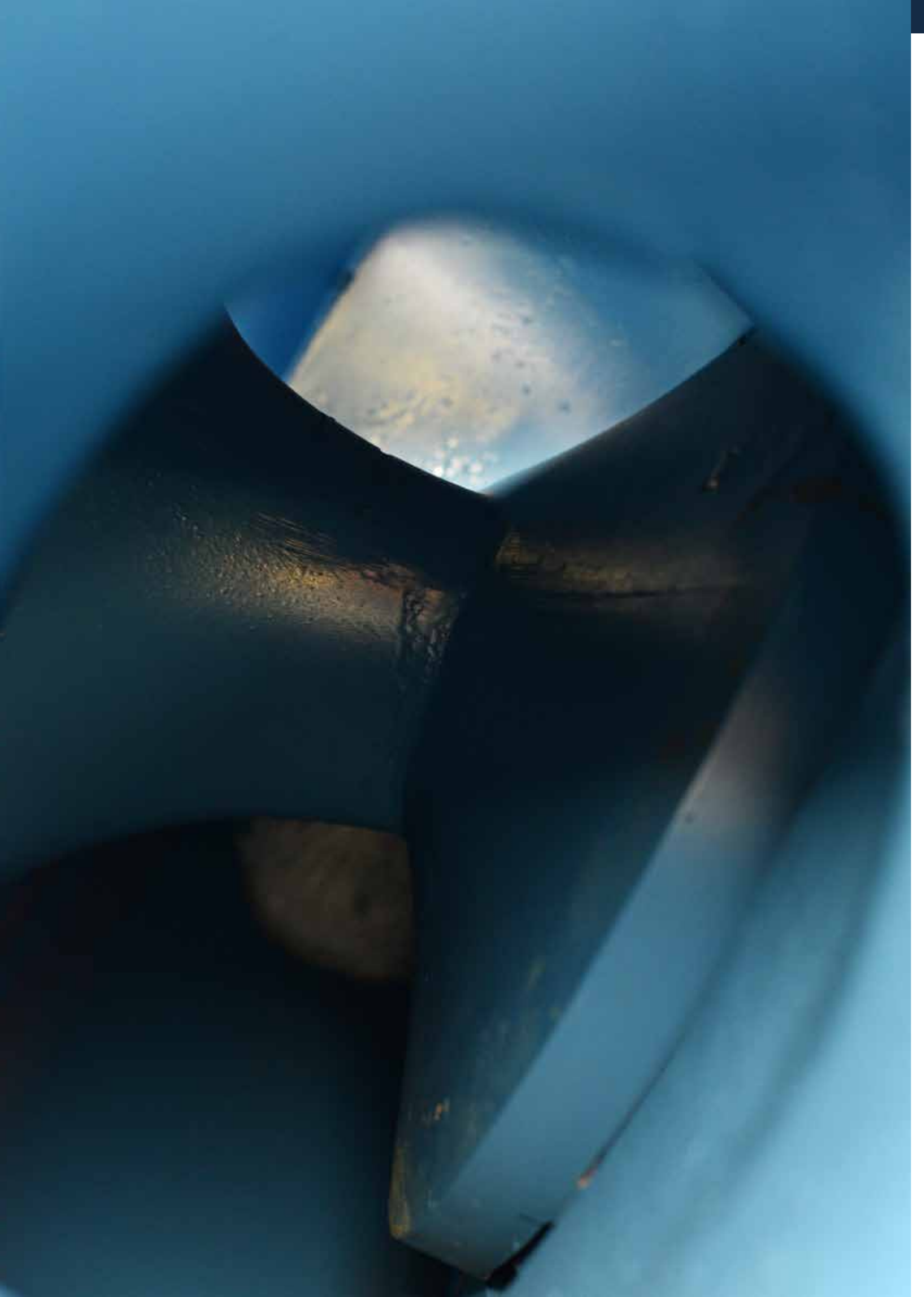



## LANDY Closed Screw Centrifugal Impeller Pumps

The closed screw centrifugal impeller pumps are a perfect combination of non-clogging performance and high efficiency. LANDY closed screw impeller pumps are designed to pump a wide variety of solids and fibrous contaminated liquids in many applications. The unique design of the self cleaning closed impeller makes these pumps superior to both channel and screw impeller pumps.

Landustrie recommends the closed screw impeller pumps in situations where standard channel pumps are clogging and higher efficiency is needed. By operating directly in the pumped liquid the installation benefits from reduced construction costs as the submersible version of these pumps do not require a special housing or structure. As they are submerged the pumps take up very little space, are quiet and do not require extra cooling. The submersible pumps are smaller than the dry installed version as they have the motor and hydraulics in one unit. That is why pump stations for the submersibles are smaller and less complex to build.

### Constant performance – Low maintenance

The shape of the impeller eliminates blockage problems. No adjustments or replacement of wear rings are necessary to maintain performance. Thus guaranteeing long-term, constant high performance with minimal maintenance, which means the total cost of ownership is therefore extremely low.



### Advantages

- Best balance between non-clogging and high efficiency
- Suitable for large volumes
- Reliable principle
- Low impeller wear due to the closed design
- Reduced energy consumption
- Ideal for storm water, irrigation, drainage & dewatering

## Cast Iron DTP22/42/62

The solids handling performance in combination with high efficiency of this range makes these pumps your first choice for most applications.

**Options:**

BWK / OWK / VRS / Cooling jacket

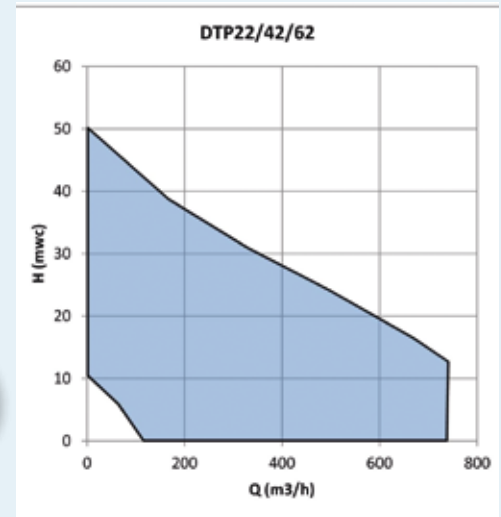

## Duplex DTP22/42/62 - U

In Duplex the solids handling performance in combination with high efficiency of this range makes these pumps your first choice for most chemical, abrasive or the combination of the both applications.

**Options:**

BWK / OWK / VRS / Cooling jacket

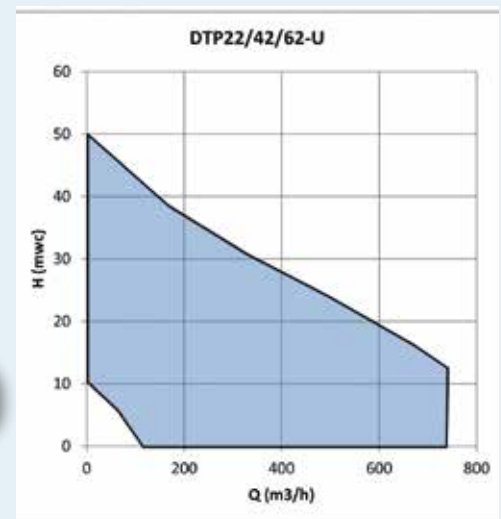

## Cast Iron BTP22/42/62/82

The solids handling performance in combination with high efficiency of this range makes these pumps your first choice for most applications.

**Options:**

HX / HS / HM / HF / KM / VX / VS / VM / ATEX / IEC-Ex 

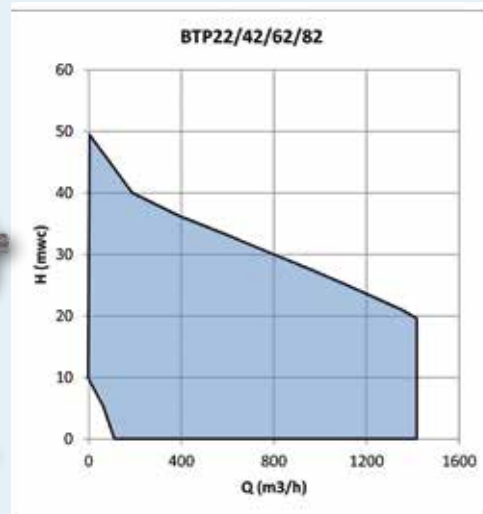

## Duplex DTP22/42/62 - U

In Duplex the solids handling performance in combination with high efficiency of this range makes these pumps your first choice for most chemical, abrasive or the combination of the both applications.

**Options:**

HX / HS / HM / HF / KM / VX / VS / VM / ATEX / IEC-Ex 

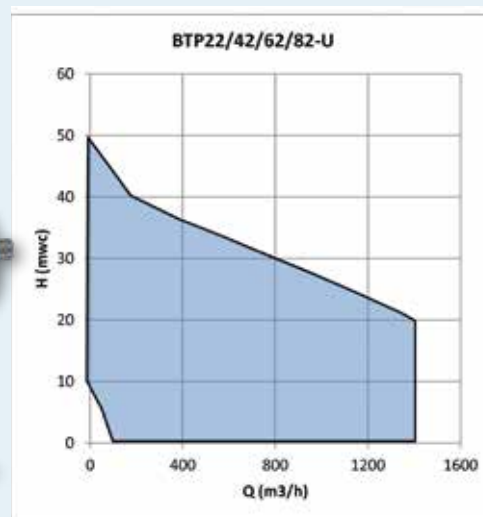
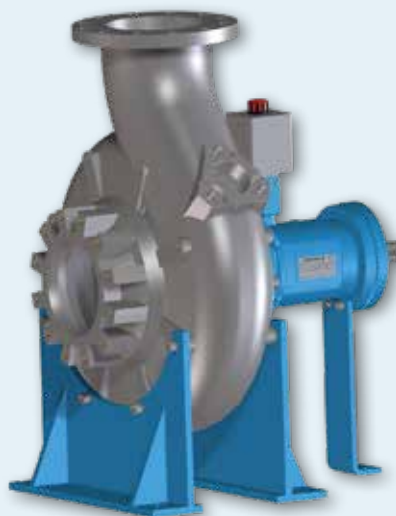



P2781

## LANDY Cutter Pumps

The LANDY heavy duty cutter pumps have been specifically designed for sewage and other wastewater applications that do not allow for large solids handling. All the solids are effectively cut into small particles that can be pumped through pipes as small as 32 mm diameter without the risk of blocking. By utilizing small diameter piping, the initial capital cost of the installation is kept to a minimum. This design has proved most successful in solving the problems associated with fibrous tissues in wastewater.

The high heads generated by these pumps enables the use of longer discharge pipes without the need for bigger motors, and they are used extensively in small sewage stations for single or groups of houses where it is not possible to utilize gravity systems. Several pumping stations can be connected to the same discharge. The extreme high head capability of these pumps, with only limited power consumption makes this range ideal in agricultural applications to feed sprinkler installations.

### CUTTING SYSTEM

The high torque cutting system cuts, where others grind, and most fragments pass the cutting system without wearing the actual cutting edges. This results in better cutting and a longer lifetime. The cutting system can be easily replaced if necessary.

### Advantages

- Heavy duty bearings greased for life
- Low motor power requirement.
- High head capability
- Adaptable
- Reliable
- Trustworthy
- Many adapters available for easy replacement of other pump brands



## SUBMERSIBLE LANDY CUTTER PUMPS

### Cast Iron DSP22-05/08

Large solids are cut into small particles that can be pumped through reduced diameter pipelines with no risk of blocking. They are often used for small sewage stations servicing single or groups of houses in areas where gravity systems cannot be utilised. In industrial applications, the cutter pumps are used when there are fibrous materials in the wastewater.

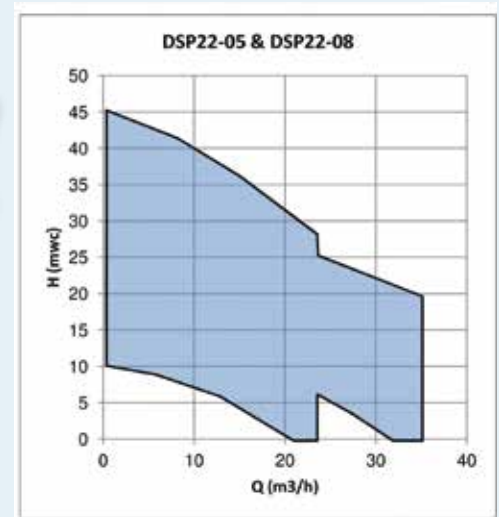

#### Options:

BWK OWK / VRS / ATEX / IEC-Ex 

## DRY INSTALLED LANDY CUTTER PUMPS

### Cast Iron BSP22-05/08

Large solids are cut into small particles that can be pumped through small diameter pipelines with no risk of blocking. They are often used for small sewage stations servicing single or groups of houses in areas where gravity systems cannot be used. In industrial applications, the cutting pumps can be used when there are fibrous materials in the wastewater.

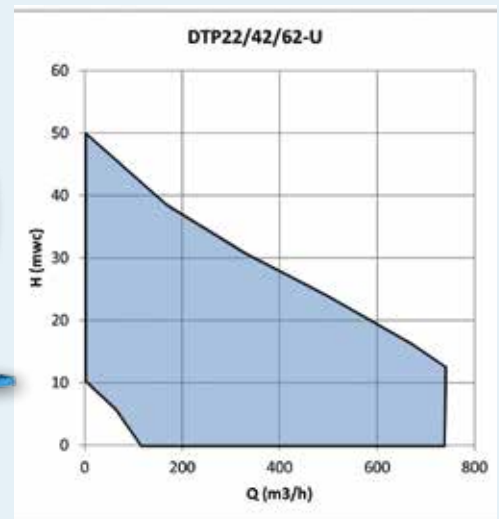

#### Options:

HX / HS / HM / HF / KM / VX / VS / VM / ATEX / IEC-Ex 

## Mixers (DWM/DNM)

LANDY mixers are designed to keep sumps, that are highly contaminated with solids and fibres, in suspension. This enables the emptying of the sump with a pump. The Vortex mixers will keep the floor clean and the sewage suspended due to the Vortex principle in all directions. You will find LANDY mixers in many industrial mixing and suspension applications. LANDY mixers can be supplied in Cast Iron, Duplex and Nihard4.

**Options:**

VRS / ATEX / IEC-Ex 

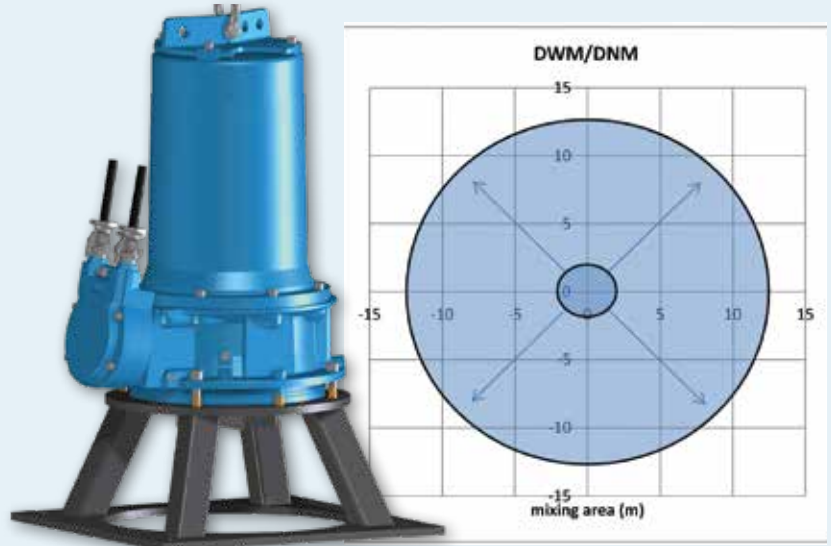

## Hydraulic motor (HNP)

LANDY pumps can be supplied with a hydraulic motor. Often used in the marine sector where an oil driven motor is preferred. In mining the hydraulic motor is preferred as it meets the stringent Explosion proof requirements. Great benefits are the compact sizes combined with very powerful motors, and no risk of overloading

**Options:**

BWK / OWK / VRS / HS / VS / ATEX / IEC-Ex 

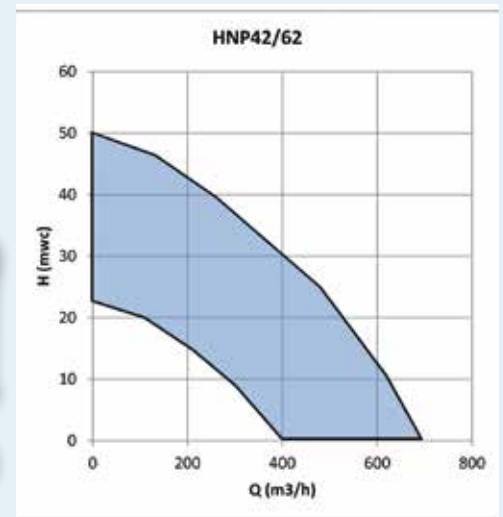
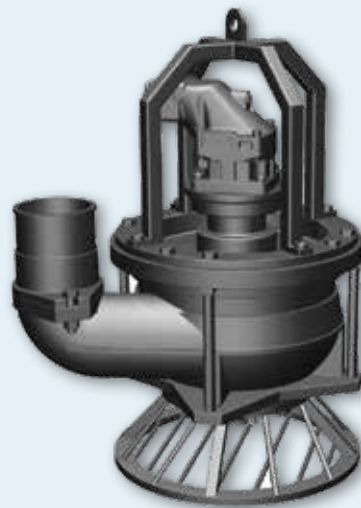

## DUCK FOOT COUPLING



For easy submersible installation, Landustrie has developed the duckfoot coupling. The pump slides easily down the guide rail(s) and will be firmly located on the duckfoot, a great advantage when servicing or checking the installation.

## Header coupling

To facilitate the building of compact installations Landustrie supplies various header couplings. The design is simple, the seal is achieved and sustained by the weight of the pump. Mounting the pump horizontally the pit/sump can be very small. One of the great advantages is a clean sump floor due to the Vortex developed in the sump. When lifting the pump all parts of the coupling are visible and available for inspection. In deeper sumps and/or when installing heavy pumps we advise a duckfoot coupling.





VERTICAL



Without options



Optional: claw for Duckfoot



Optional OWK duckfoot coupling set



Vertical with hose connection or threaded connection



(VRS) Vertical freestanding optional hose connection or threaded connection



Optional BWK header coupling set

HORIZONTAL



Without options



With hose connection and/or suction elbow



Optional BWK header coupling set

## INSTALLING SUBMERSIBLE LANDY PUMPS WITH COOLING JACKET

### VERTICAL

OWK, BWK, VRS are available as shown on page "Installing Submersible LANDY Pumps".



With the immersible installation option

### HORIZONTAL



Without options

## INSTALLING SUBMERSIBLE LANDY NI-HARD4 PUMPS (DNP)

OWK, BWK, VRS are available as shown on page



Vertical without options



Vertical with agitator, stand and discharge bend  
With hose or threaded connection



Vertical slimline, with agitator, stand and hose or threaded connection

VERTICAL



(VX) Bare shaft



(VS) Short coupled



(VS) Short coupled with optional immersible installation



(VM) With flexible coupling and fixed electric motor



(VM) With flexible coupling and fixed electric motor with optional immersible installation

HORIZONTAL



(HX) Bare shaft



(HS) Short coupled



(HM) With spacer coupling, base frame and electric motor



(HF) With flexible coupling, base frame and fixed electric motor



(KM) With frame, V-belt drive and electric motor

# Over 250 years of experience in water handling and treatment

From water intake systems to water cooling, from water management to wastewater treatment, hydropower, pump installations, and award-winning innovations in decentralized wastewater treatment; DeSaH, Hubert, and Landustrie have joined forces. Based in Sneek, Friesland, our craftsmen develop and manufacture future-proof solutions with an above-average lifespan.

## **Landustrie Sneek BV**

P.O. box 199 | NL-8600 AD SNEEK, The Netherlands

Tel. +31 515 48 68 88

E-mail [info@landustrie.nl](mailto:info@landustrie.nl) | Website [www.landustrie.de](http://www.landustrie.de)

Office address Pieter Zeemanstraat 6, Sneek

